

Article number: 0105052

Description: Retaining ring AV 35

Note: Fitted with ZGA pliers

Measures

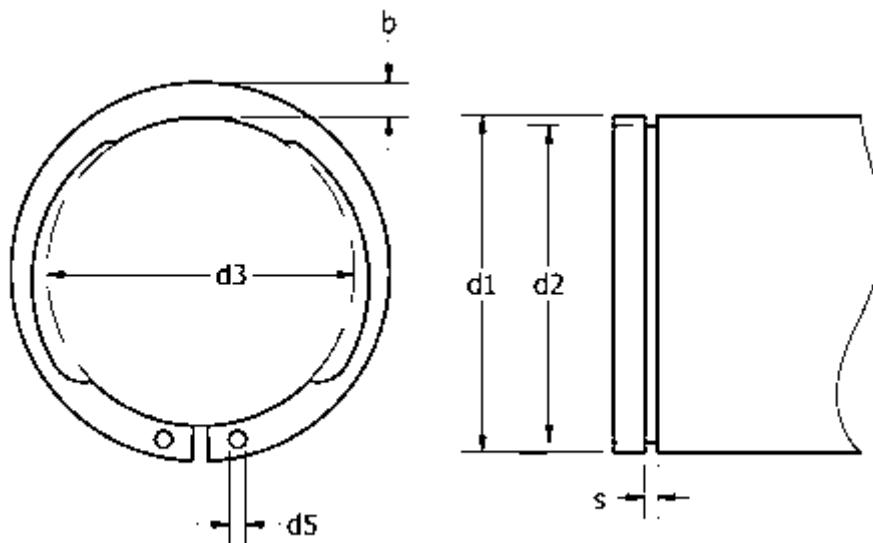

AN mm ²	= 48.0	FRg kN	= 4.6	t	= 1.00
b	= 4.2	FR kN	= 26.6	tol	= -0.06
d1	= 35	g	= 2.0	tol	= -0.25
d2	= 33.0	K kN-mm	= 50.1	tol	= +0,25-0,50
d3	= 32.20	m min	= 1.60	tol	= 0.1
d5 min	= 2.0	n abl x 1000	= 16	Tong	= ZGA-2
Description	= AV 35	s	= 1.50	Weight kg/1000	= 4.53
FN kN	= 8.00	Side power N at I2	= 2.5		